





One step ahead

STIEBEL is one of the world's leading providers of drive units for mobile hydraulics and materials handling technology. Wherever around the globe the most demanding requirements are called for, our products are used preferably. STIEBEL stands for quality, innovation and close customer proximity. For over 60 years now. Highly-qualified staff ensures that we can live up to our excellent

reputation as a specialist for quality of the tallest order – both now and in the future. From planning and engineering through to production – STIEBEL provides the very best service in every phase of a project. Wherever.

You have the tasks to be solved. We have the solution. A perfect match.





Pump Drives

Power – wherever it is needed

Usage in mobile machinery places diverse demands on all components involved, above all on the drive unit, though. Besides sheer power it is first and foremost reliability, low maintenance and efficiency which are called for. Wherever hydraulic pumps allocate the working power in mobile appliances, STIEBEL offers a standard gear range capable of

transmitting powers of 100 up to 1,600 kW. A modular system, designed perfectly down to every little detail and with a unique integrated lubrication system. Produced using cutting edge machinery to ensure the highest possible quality. The only way which will come up to your expectations.



Pump Drives
Special gear
units for mobile
machinery

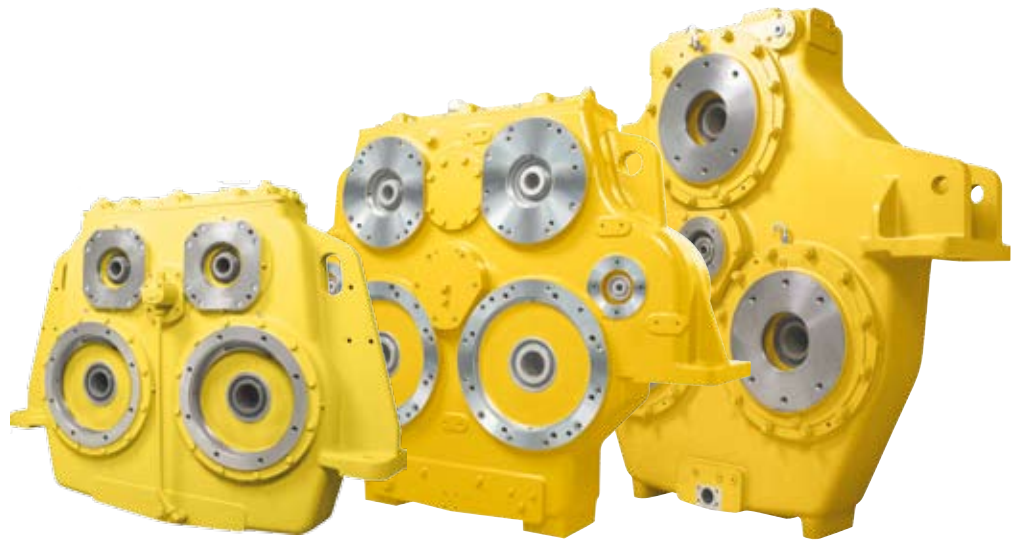

Flexibility is our driving force

Especially in mobile applications you often face special challenges which demand design of a highly individual nature. We have gained extensive experience in developing such customized solutions in close cooperation with our customers. Prompt and exact. Tough conditions in harsh terrain are the rule rather than

the exception – yet this does not prevent our powerful gear units from working perfectly reliably at all times. You will have up to 2,000 kW of power transmission at your disposal.

Calculate with that power for any application you wish. We will make certain it works perfectly.

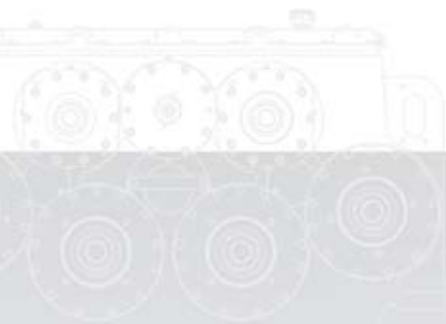

QuarryMaster
Conveyor drive units



Ensuring progress through close contact

When it comes to materials handling STIEBEL has been able to provide a solution for almost any application, for many years now. This begins with competent advice and results in an unrivalled price-performance ratio thanks to the exceptional reliability of our products. Prompt contract implementation and strict delivery reliability are

usually considered standard by our customers. With our outstanding “Ing.” engineering service available to you around the clock, however, we often amaze our customers.

And if the worst comes to the worst, we will be just where you need us – anywhere in the world – thanks to our international presence.



QuarryMaster
HighPower
Drive Groups



Power source for your project

We know quite a lot about this world and are well aware of the extreme conditions in which our products have to work perfectly. In response to these requirements we have developed the QuarryMaster HighPower high-performance gear units. We provide you with the power required, allowing you to give your

creative designs a free rein. You can rest assured. The QuarryMaster HighPower excels through its extremely compact construction and is not only extremely powerful, but also tremendously robust and durable. We can adapt the QuarryMaster precisely to your special requirements.

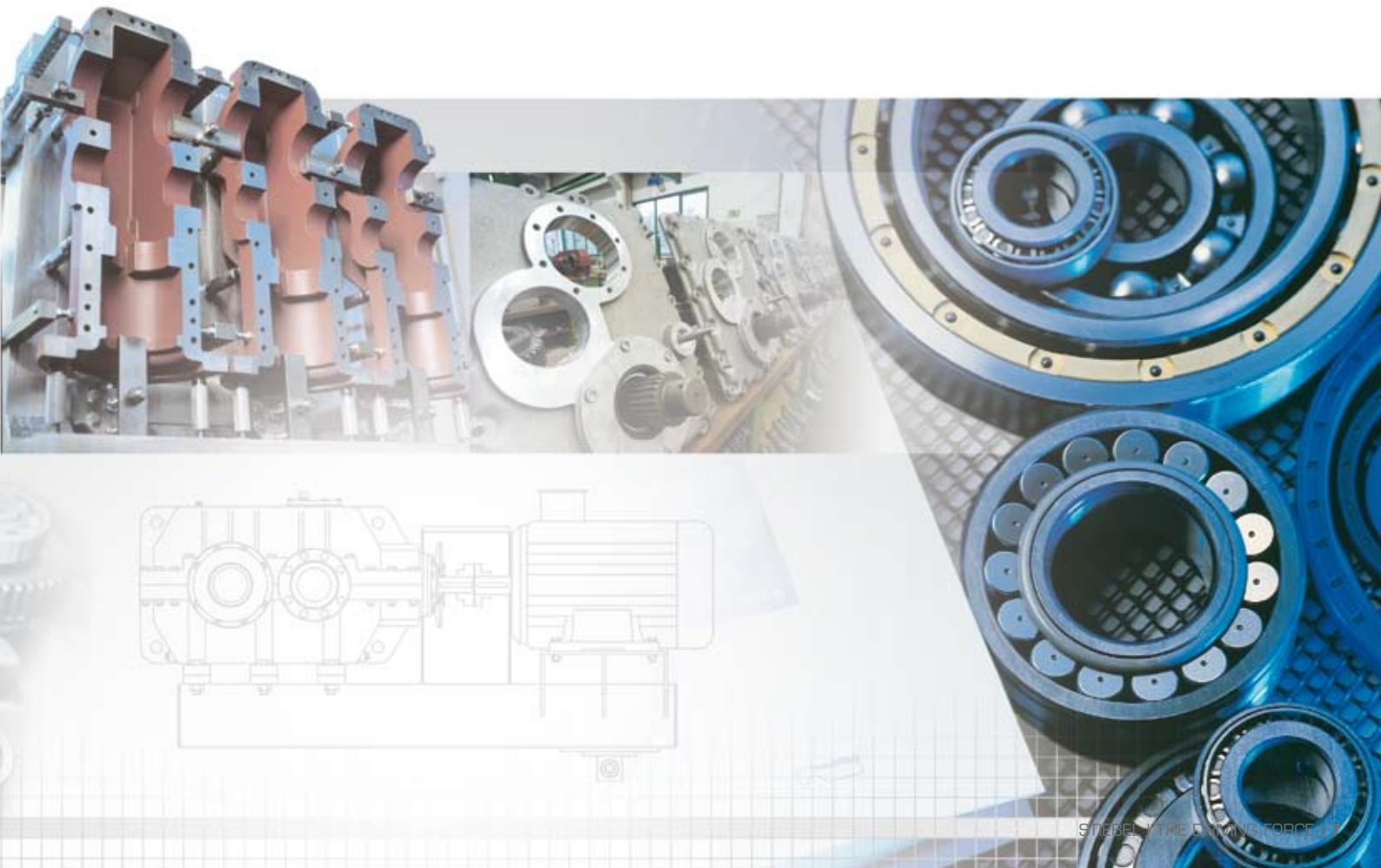

Hoist gear units
Special gear unit
for harbour logistics

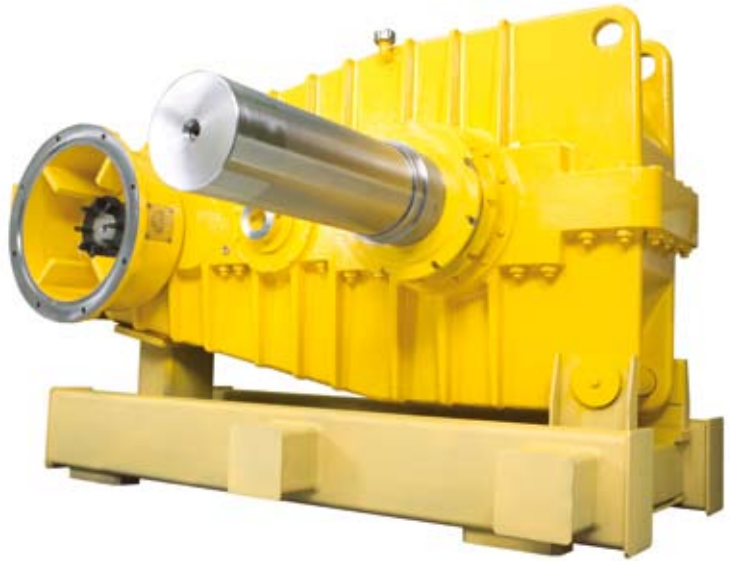

Just the way you need it

STIEBEL gear units are rarely bought off the peg. Our customers often come up with the most unusual ideas, that is why we have developed certain skills to offer customized solutions to even the most demanding requirements.

We begin by examining every detail of your project, allowing you to benefit from our extensive expertise right at the planning stages.

What we work out jointly with you is then realized with maximum precision deploying state-of-the-art machinery. The result is a tailor-made solution to meet your individual requirements. No ifs and buts.

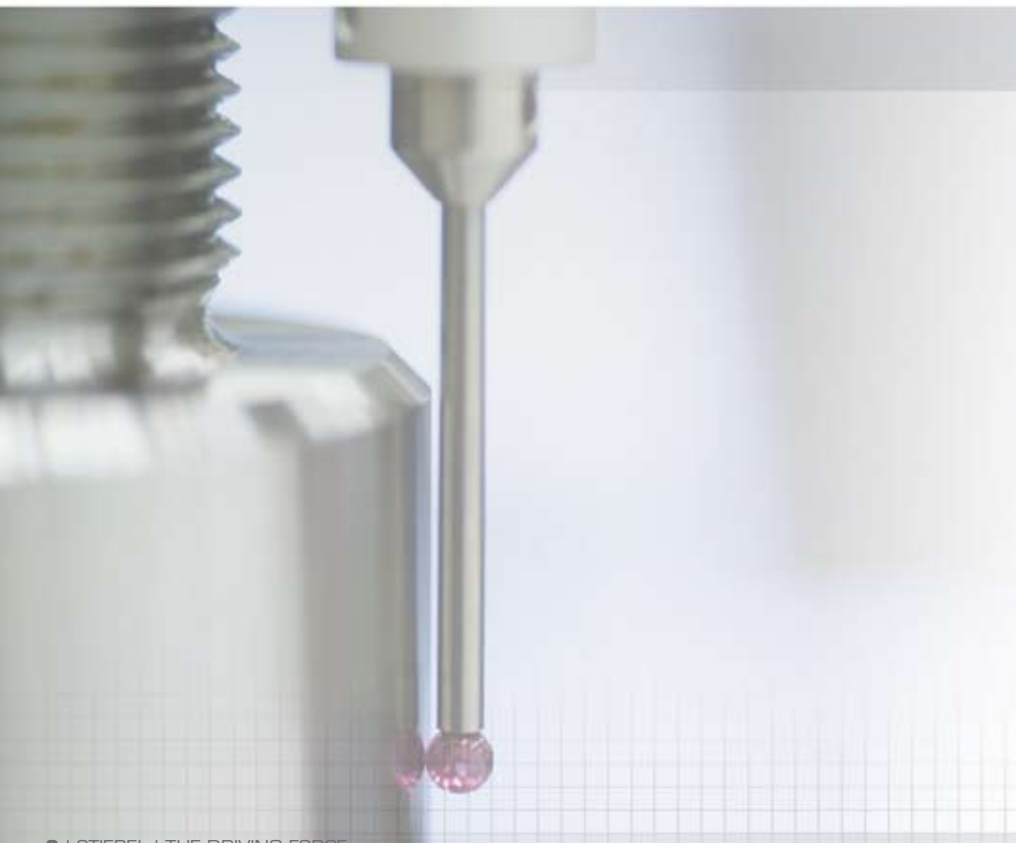

Helical gear
Special gear unit
for draw stand for
filaments



Values for generations

It is not the capital which brings about success, it's a creative spirit. The success of our company is not simply determined by balance books, but rather by who we are and what we stand for. At the heart of our activities are those immaterial values which underpin our lasting strength in a process of continuous change. It is the central task of the Management to steer this course

through change. At the same time, we concentrate on our strong points and appreciate the commitment and loyalty of our staff. Our leitmotif of a "driving force" symbolizes our products and services as well as the future-oriented development of our company in conjunction with our responsibility towards the environment and society. We aim at providing real benefits.

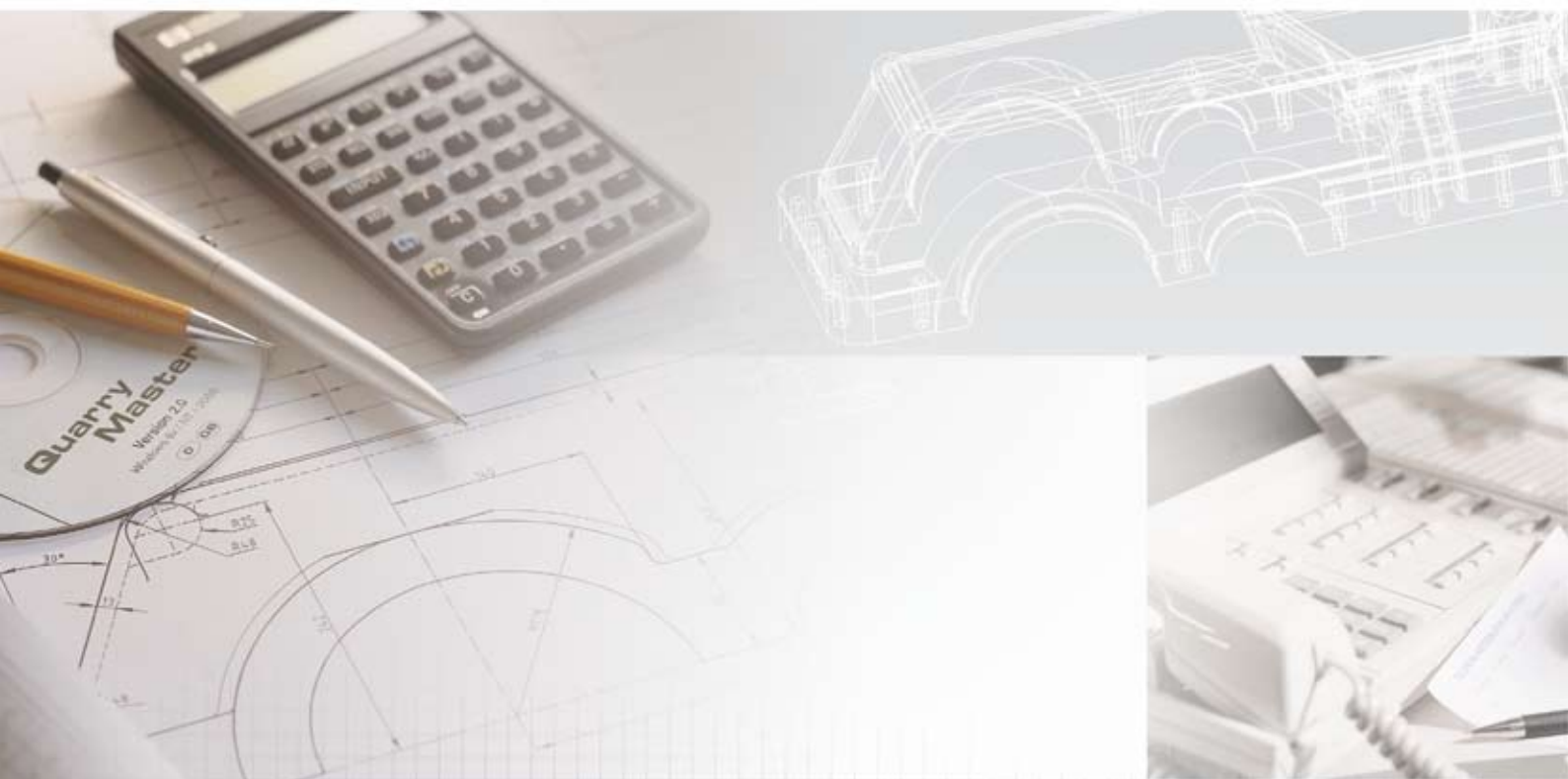

Special Gear Units

Custom-made Drive Solutions

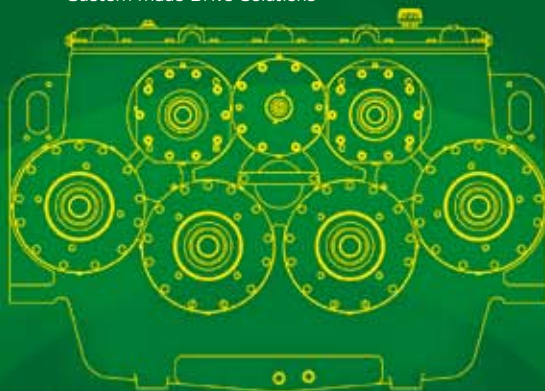

P 2000
Pump Drives

QuarryMaster®

Helical-bevel Geared Motors

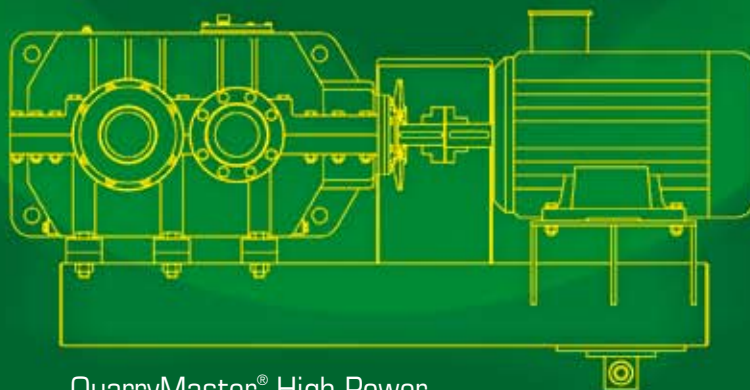

QuarryMaster® High Power

Drive Groups



Stiebel-Getriebebau GmbH & Co. KG
Industriestr. 12
D-51545 Waldbröl
Germany

Management:
Paul Hermann Schumacher
Joachim Gröschl

Phone +49 (0) 2291 791-0
Fax +49 (0) 2291 791-290
Email: info@stiebel.de
Internet: www.stiebel.de

Infocall 00800 – Stiebel
ServiceHotline +49 (0) 1802 - Stiebel